

Betta FLO

SELF-PRIMING CENTRIFUGAL PUMPS BMLS-M & BMLS-H

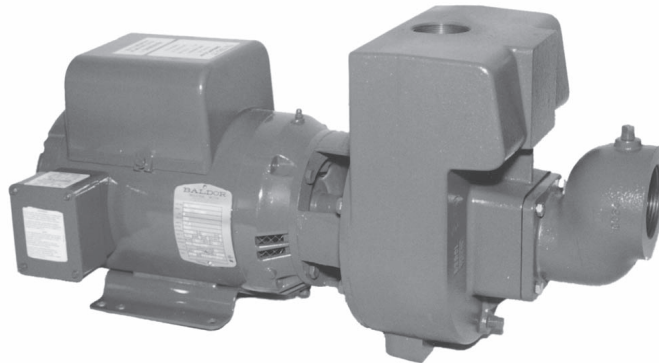

INSTALLATION, OPERATION & MAINTENANCE INSTRUCTIONS

HP	Phase	Medium Head	High Head
3	1	BMLS 300 M	BMLS 300 H
3	3	BMLS 300 M3	BMLS 300 H3
5	1	BMLS 500 M	BMLS 500 H
5	3	BMLS 500 M3	BMLS 500 H3

GENERAL INSTRUCTIONS

Examine unit for any visible shipping damage. Immediately report any damage to the carrier. Check all accessory parts carefully against the invoice. All pipe used should be clean and free from rust and scale. Use pipe joint compound on all joints to avoid leaks.

INSTALLATION & OPERATION

Pump Location: Locate the pump as near the well or water source as possible, using short, direct suction pipe. Keep the static suction lift (vertical distance between the center line of the pump and water level) to a minimum. Mount the pump on a solid, level foundation, which provides a rigid

and vibration free support. It should be located where the unit is readily accessible for service and maintenance. The pump should be protected against flooding and excessive moisture.

Piping: Both suction and discharge piping should be independently supported at a point near the pump to avoid strains being placed on the pump. Start all piping at pump to avoid strains left by a gap at last connection. It is advisable to increase the size of both suction and discharge piping at the pump if any appreciable run of pipe is required. Never use a smaller suction pipe than the suction connection on the pump.

Suction Piping: The suction pipe must be kept free from air leaks. The suction pipe must have a gradual slope upward to the pump. Avoid any fittings which may cause an air trap. A check valve is a built-in feature and no foot valve is required.

Discharge Piping: A gate valve and union should be installed in the discharge line. For removal of the pump for service, close the gate valve, and disconnect at the union.

Priming the Pump: A tee installed in the discharge opening of the pump and provided with a priming plug at the top position; will enable you to fill the pump with water. Once filled and the priming plug replaced, the pump will prime. The priming time depends upon the vertical and horizontal distance between the pump and the water level. The pump should prime itself time after time as long as the built-in check valve functions.

CAUTION: DO NOT run the pump before filling the pump case with liquid, as it may damage the seal.

Storage of Pump: Drain liquid from pump to prevent freezing. It is recommended that a good rust inhibitor be put in the liquid and to prevent excessive corrosion. Be sure motor is kept dry and covered.

When restoring the use of the pump, replace all plugs and make sure all connections are tightly sealed. After a complete check is made, make the initial prime according to directions under the section, Priming the Pump.

ELECTRICAL

WIRING:

Check wiring and fuse charts before connecting wires to service lines. Make sure the voltage and frequency of the power supply agrees with what is stamped on the motor nameplate. If in doubt, check with the power company.

Single Phase: Determine incoming voltage to motor. Where possible, use 230V. Connect wiring to terminal board located

inside conduit box cover. Be sure voltage connections agree with wiring diagram on motor nameplate.

Three Phase: Three phase motors require magnetic starters, and can run in either direction, depending on how they are connected to the power supply.

To Check for Proper Rotation: Remove the motor end cover. This exposes the motor shaft. If hook-up is correct, the shaft will rotate clockwise. If rotation is not clockwise, reverse any two leads to the starter. The rotation will now be correct.

GROUNDING THE MOTOR:

WIRING TO THIS PUMP MUST BE INSTALLED AND MAINTAINED IN ACCORDANCE WITH THE NATIONAL ELECTRICAL CODE OR YOUR LOCAL ELECTRIC CODE. IF MORE INFORMATION IS NEEDED, CALL YOUR LOCAL LICENSED ELECTRICIAN OR YOUR POWER COMPANY.

Permanently ground the motor in accordance with the National Electrical Code Article 250 or applicable local codes and ordinances. It is recommended that a permanent ground connection be made to the unit using a conductor of appropriate size from a metal underground water pipe or a grounded lead in the service panel. Do not ground to a gas supply line. Do not connect to electric power supply until unit is permanently grounded. Connect the ground wire to the approved ground and then connect to the terminal provided.

A metal underground water pipe or well casing at least 10 ft. long makes the best ground electrode. If plastic pipe or insulated fittings are used, run ground wire directly to the metal well casing or use ground electrode furnished by the power company.

There is only one proper ground connection on the motor. It is located under the motor canopy and is painted green and identified as GRD. Ground connection must be made to this terminal. See wiring diagram on next page.

**TABLE 1
RECOMMENDED FUSING & WIRING DATA—60 CYCLE MOTORS**

Motor HP	Phase	Volts	Full Load Amps	Branch Fuse* Rat. Amps	Distance in Ft. from Meter to Motor				
					0'-100'	101'-200'	201'-300'	301'-400'	401'-500'
Wire Size									
3	1	230	16.0	20	12	12	10	8	8
3	3	230	7.6	15	14	14	14	12	12
3	3	460	3.8	15	14	14	14	14	14
5	1	230	24.0	30	10	10	8	6	6
5	3	230	14.0	20	12	12	12	10	8
5	3	460	7.0	15	14	14	14	14	14

*Fusetrons are recommended instead of fuses on all motor circuits

WIRING DIAGRAM: 10-32 GROUND SCREW (BINDING HEAD)

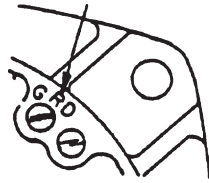

The motor grounding conductor need not be larger than the circuit conductors supplying the motor providing circuit conductors conform to the wiring data provided in this manual.

PUMP SERVICE

This pump requires little or no service other than reasonable care and periodic cleaning. The trap on suction trap models should be reasonably clean at all times. After a reasonable time of operation, the shaft seal may become worn and require replacement. Follow the procedure as outlined in this manual.

THE SHAFT SEAL:

The shaft seal consists of two parts, a rotating member and a ceramic seat.

CAUTION: The highly polished and lapped faces of the seal are easily damaged. Read instructions and handle the seal with care.

REMOVAL OF OLD SEAL:

1. Remove 8 capscrews which hold the motor and adapter to the pump body, and pull away as an assembly. Be careful not to damage adapter gasket.
2. The impeller is keyed on the shaft. Remove impeller screw, turn counter-clockwise, and slide impeller off of shaft. NOTE: Be careful not to damage gaskets and washer. It is not necessary to remove the key. Carefully remove the rotating parts of the seal by prying up on the sealing washer with two screwdrivers. (Figure 1)
3. Remove 4 capscrews which hold adapter to motor housing and lay adapter on a clean surface.

4. Pry loose the ceramic seal by applying a screwdriver between the seat and cavity in the adapter. Clean the cavity from which seal was removed and the motor shaft. (Figure 2)

INSTALLATION OF NEW SEAL:

1. Bolt adapter back on motor housing.
2. Clean polished surface of ceramic seat with a clean cloth.
3. Wet the "O" ring in the ceramic seat with soap solution.
4. Press seat into cavity firmly and squarely with finger pressure. If seat will not locate properly in this manner, place cardboard washer over polished face of seat, and use piece of standard pipe for pressing purposes. (Figure 3)
5. Dispose of cardboard washer and again ascertain that polished surface of seat is free of dirt or foreign particles, and has not been scratched or damaged by the insertion.
6. Inspect shaft to make sure that it is clean.
7. Clean face of rotating sealing washer with clean cloth.
8. Apply soap solution to inside diameter and outer face of rubber drive ring.
9. Slide seal assembly on shaft (sealing face first) as far as possible. This will insure a tight seal. Replace gasket against shaft seal.
10. Slide impeller on shaft with key in position. Place gasket, washer and gasket back in position on motor shaft. Tighten impeller screw in shaft. (Figure 4)
11. Reassemble pump.

MAINTENANCE:

Be sure to drain pump during freezing weather to prevent damage from frost. To drain, remove priming plug, or suction trap cover, and drain plugs directly below the suction inlet of the pump. Drain the suction pipe to a joint below the frost line. All other pipes that may be exposed to freezing temperatures should also be drained. Store the pump as directed in the section under Storage of Pump.

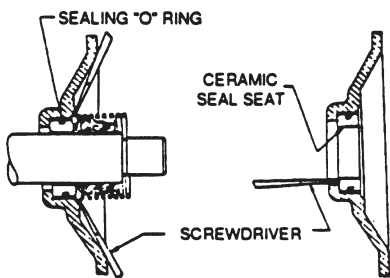

FIGURE 1

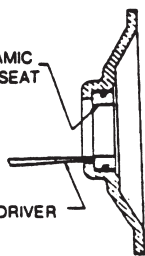

FIGURE 2

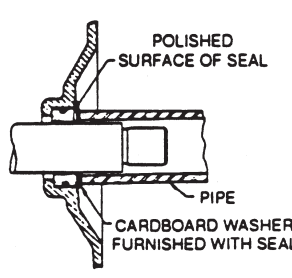

FIGURE 3

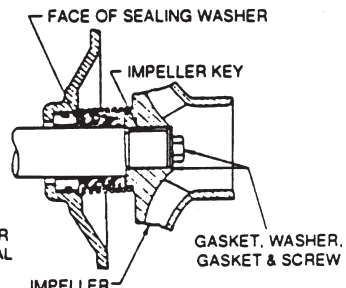

FIGURE 4

TROUBLE AND CAUSE	REMEDY
<p>Failure to Pump</p> <ol style="list-style-type: none"> Pump not properly primed. Speed too low. Total head more than that for which pump was intended. Suction lift too great. 	<ol style="list-style-type: none"> Make sure pump casing and suction line are full of water. See Priming Instructions. Check voltage at motor terminals and at meter when pump is operating. If low, refer to wiring instructions, or check with your Power Company. Check loose connections. A pump designed for higher head is needed. Locate pump closer to source of water. Make sure suction piping is large enough.
<p>Reduced Capacity and/or Head</p> <ol style="list-style-type: none"> Air pockets or leaks in suction line. Clogged impeller. Strainer too small, or clogged. Insufficient submergence of suction pipe. Excessive suction lift. Total head more than that for which pump was intended. Excessively worn impeller and wearing ring. 	<ol style="list-style-type: none"> Check suction piping. Remove and clean. Use larger strainer, or clean. Add lengths of suction pipe to keep submerged and well below the water surface. If caused by suction pipe friction, enlarge piping. Otherwise, move pump closer to water level. A pump designed for higher head is needed. Order replacement parts using Repair Parts List in this manual.
<p>Pump Loses Prime</p> <ol style="list-style-type: none"> Air leaks in suction line. Excessive suction lift and operating too near shut-off point. Water level drops while pumping, uncovering suction piping. 	<ol style="list-style-type: none"> Check suction piping. Move pump nearer water level. Check water supply. Add length of pipe to suction to keep submerged and under water.
<p>Mechanical Troubles and Noise</p> <ol style="list-style-type: none"> Bent shaft and/or damaged bearings. Suction and/or discharge piping not properly supported and anchored. 	<ol style="list-style-type: none"> Take motor to authorized motor repair shop. See that all piping is supported to relieve strain on pump assembly.

**TABLE II
SPECIFICATION & PERFORMANCE CHART—BMLS-M & BMLS-H**

Model	Pump Size		HP	Gallons Per Minute Against Total Head in Feet												Max. Shut-Off Head (Feet)	Max. PSI
	Suct.	Disch.		20	30	40	50	60	70	80	90	100	120	140	150		
BMLS300M	2-1/2	2	3	190	180	165	152	140	120	105	85	60	—	—	—	113	49
BMLS300H	2	2	3	127	124	120	115	109	100	93	85	76	55	—	—	140	61
BMLS500M	3	2-1/2	5	240	235	225	213	200	190	180	165	150	120	60	—	144	63
BMLS500H	2-1/2	2	5	164	162	160	156	153	150	144	137	130	110	85	40	165	72

BMLS SERIES REPAIR PARTS

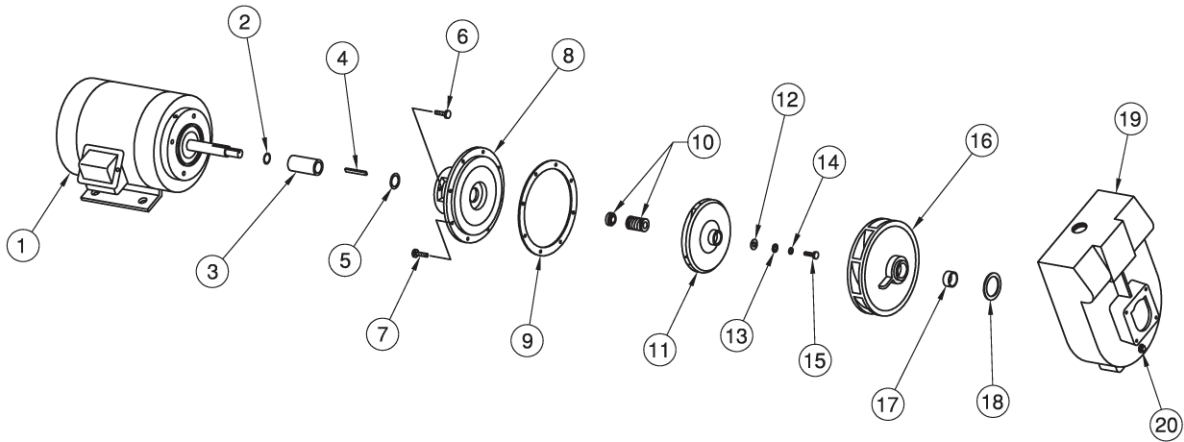

ITEM #	PART #	QTY.	DESCRIPTION
1	N.A.	1	SEE JM MOTORS
2	BMLS3/5DO-200	1	BUNA O-RING
3	BMLS3/5SS-107	1	SHAFT SLEEVE
4	BMLS3/5KE-102	1	IMPELLER KEY
5	BMLS3/5SG-200	1	SHAFT SLEEVE GASKET
6	EXP0198000126	4	3/8-16 X 1 CAP SCREW
7	EXP0198000126	8	3/8-16 X 1 CAP SCREW
8	BMLS3/5MB-101	1	MOTOR BRACKET
9	BMLS3/5HG-200	1	HOUSING GASKET
10	BMLS3/5SK-200	1	TYPE 43 ROTARY SEAL
11	BMLS300IM-1M5	1	3 HP MEDIUM HEAD IMPELLER
11	BMLS500IM-1M5	1	5 HP MEDIUM HEAD IMPELLER
11	BMLS300IM-1H5	1	3 HP HIGH HEAD IMPELLER
11	BMLS500IM-1H5	1	5 HP HIGH HEAD IMPELLER
12	BMLS3/5IG-200	1	IMPELLER GASKET
13	BMLS3/5IW-107	1	CONE S.S. IMPELLER WASHER
14	EXP0238000031	1	3/8" ZINC LOCK WASHER
15	EXP0198000207	1	3/8-16 X 1-1/4 S.S. BOLT
16	BMLS3/5DFR-1M1	1	3 HP MEDIUM HEAD DIFFUSER
16	BMLS500DFR-1M1	1	5 HP MEDIUM HEAD DIFUSSER
16	BMLS3/5DFR-1H1	1	3 & 5 HP HIGH HEAD DIFUSSER
17	BMLS500WR-1M5	1	5 HP MEDIUM HEAD WEAR RING
17	BMLS300WR-1M5	1	3 & 5 HP MEDIUM HEAD WEAR RING
18	BMLS3/5DG-200	1	DIFFUSER GASKET
19	BMLS3/5HS-131	1	1-1/2" DISCHARGE HOUSING
19	BMLS3/5HS-141	1	2" DISCHARGE HOUSING
19	BMLS3/5HS-151	1	2-1/2" DISCHARGE HOUSING
20	EXP0168000161	1	1/4" PLUG

BMLS SERIES REPAIR PARTS 3 HP 5 HP SUCTION FLANGES

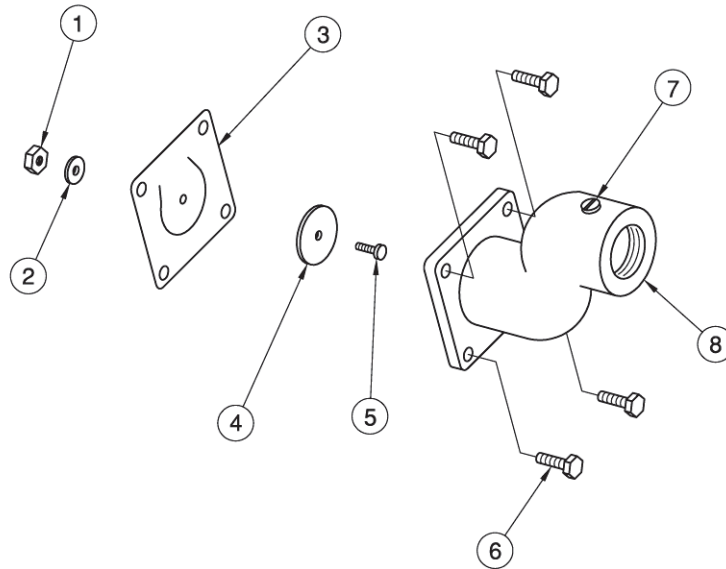

ITEM #	PART #	QTY.	DESCRIPTION
1	EXP0148000027	1	1/4-20 S.S. NUT
2	BMLS3/5FW-200	1	S.S. WASHER, FLAPPER GASKET
3	BMLS3/5FG-200	1	FLAPPER GASKET
4	BMLS3/5WH-200	1	LG. S.S. WASHER
5	EXP0198000117	1	1/4-20 X 1/2" S.S. SCREW
6	EXP0198000110	4	5/16-18 X 1" CAP SCREW
7	EXP0168000161	1	1/4" PLUG
8	BMLS3/5SF-141	1	2" SUCTION FLANGE
8	BMLS3/5SF-151	1	2-1/2" SUCTION FLANGE
8	BMLS3/5SF-161	1	3" SUCTION FLANGE